



# ALSPEC DURASLAT® FENCING SYSTEM



# DURASLAT®

*"...built on the back of Alspec's architectural systems knowledge, balancing the need for both form and function..."*

## ALSPEC DURASLAT® FENCING SYSTEM Architectural Form and Innovative Design

The Alspec DuraSlat Fencing System is a suite of specifically designed extrusions that provides a premium concealed fixed screening solution for use in both domestic and commercial fence and screening applications.

Unlike other screw together screen and fencing options, the DuraSlat Fencing System has been built on the back of Alspec's sophisticated architectural systems experience. As a result, the Alspec DuraSlat Fencing System is an innovative, cost effective, concealed fixed solution for fencing, privacy screening and pedestrian gates.

Similar to other Alspec systems, the DuraSlat Fencing System incorporates a stylish design balanced with the need to be simple and fast during fabrication and installation. Furthermore, the concealed fixings, coupled with structural frames and slats will deliver a robust long term solution for your next project.

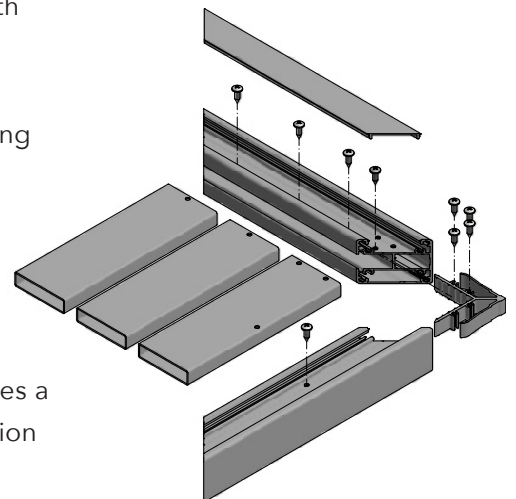



## PRODUCT FEATURES

### Simple Fabrication

**NO WELDING REQUIRED!** By eliminating the need to weld, sections can be supplied prefinished and are cut and screwed together on site or in your factory providing a strong and durable finished product. Screens and fences can be easily fabricated either by cementing posts into the ground or by bolting the specifically designed base plate to the various post sections. Slats are then positioned to the desired spacing and screwed off. Finally, all fixings are concealed with the use of our snap-on infill extrusion profiles.

- High Strength powder coated aluminium
- Resistant to warping, cracking or splintering
- Full range of hardware options
- Flexibility in gate fabrication
- Designed for all Australian weather conditions

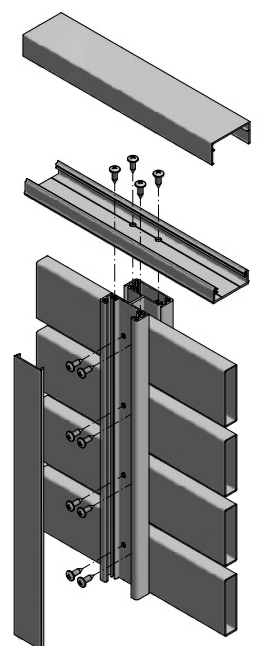





83

# DESIGN FLEXIBILITY

## Colour Range and Finish Options

Alspec has four strategically positioned advanced powder coat lines throughout Australia. These lines enable Alspec to offer > 100 colours. These powder coat options coupled with a range of timber grain finishes help position the DuraSlat Fencing System as a perfect solution for attractive and affordable screens and gates for your next project.

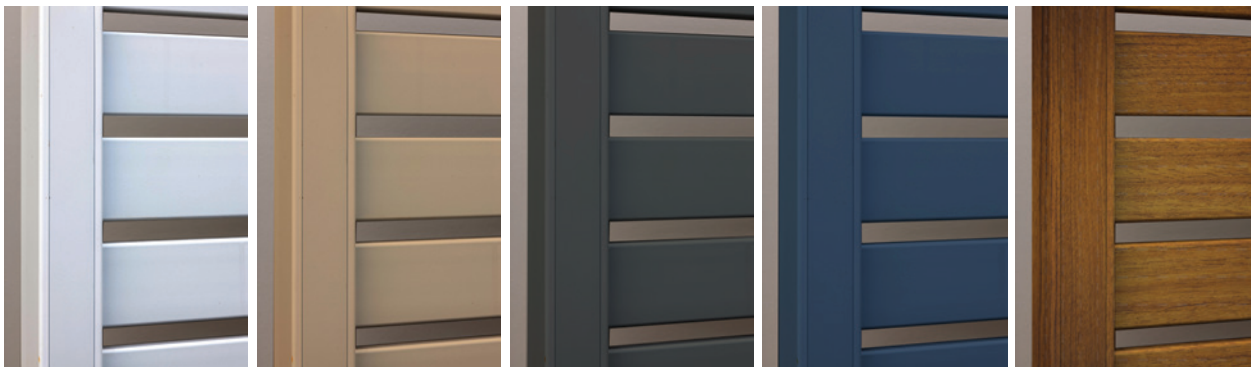

## Louvre Look

The DuraSlat slats can be further enhanced by utilising our 140 degree self spacing connectors. By tilting the slat, enhanced privacy is achieved, whilst still allowing air flow and light. The connectors are made from UV stabilised glass filled nylon, which offer improved strength and durability.

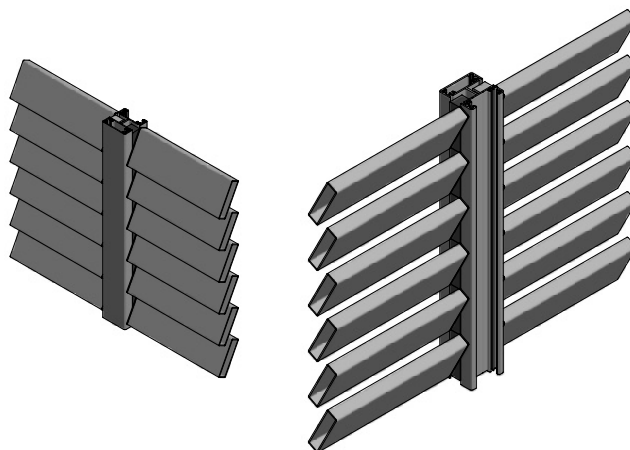

## Pedestrian Gates

The DuraSlat Fencing System has been designed and tested for use as pedestrian gates when used in conjunction with our structural DuraSlat profile. Pedestrian gates are easily fabricated using mitred corners and custom designed corner stakes with integrated screw locators to ensure gates are true and square. Furthermore, our gate frame has been specifically reinforced to offer improved gate hardware life through increased sectional wall thicknesses at fixing points.

## Technical Support

For further information or to get a copy of the DuraSlat Fencing System Technical Manual which details section information, cutting and slat configurations, please contact your nearest Alspec Branch or Area Manager.

# DURASLAT® PROFILES

## DuraSlat® Extrusions & Infills

**FP50**  
1 WAY POST / GATE POST  
1629553

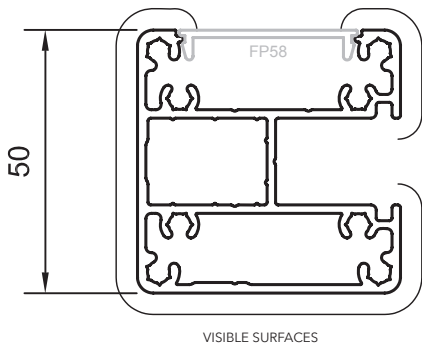

**FP52**  
2 WAY POST  
1629555

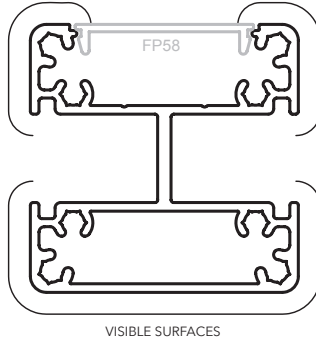

**FP57**  
90 Deg POST  
1629560

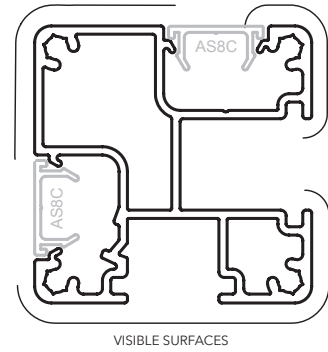

**FP56**  
CHANNEL  
1629559

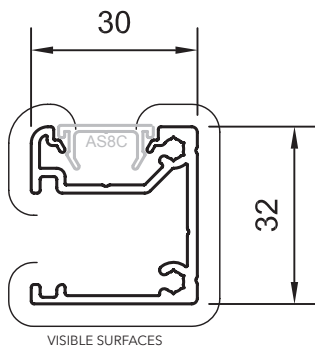

**FP55**  
SQUARE TOP RAIL  
1629558

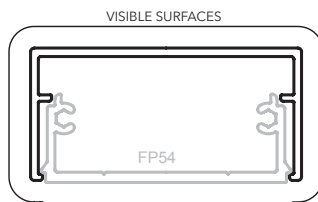

**FP58**  
POST INFILL  
1620113

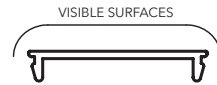

**FP54**  
TOP RAIL BASE  
1629557

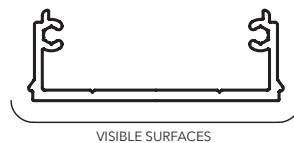

**AS8C**  
CHANNEL INFILL  
1600080



## Slat Options

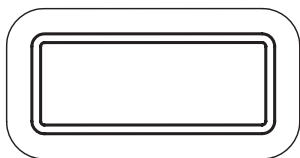

**SLAT**  
38 x 16 x 1.2 Wall  
1131117

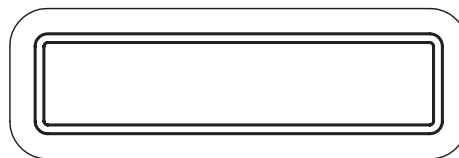

**DURASLAT**  
65 x 16 x 1.4 Wall - Structural Alloy  
1995711

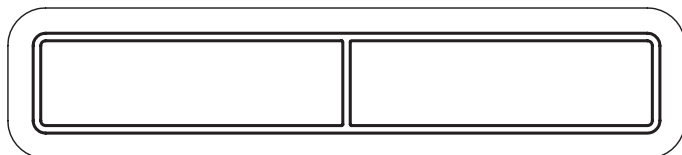

**SLAT**  
100 x 16 x 1.2 Wall  
1132904

VISIBLE SURFACES

\*\*Not to Scale\*\*



# DURASLAT® ACCESSORIES & HARDWARE

The DuraSlat Fencing System comes with a comprehensive range of accessories which includes items such as self drilling screws, D&D gate hardware, base plates, post caps, spacing blocks and Alspeck Touch Up Paint.

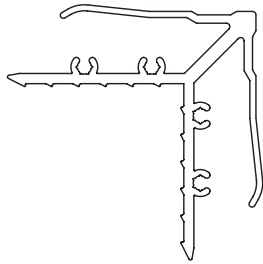

**FPA1 GATE SPIGOT**

Part # 1311300

Finish: Mill Finish Aluminium

Qty: Each

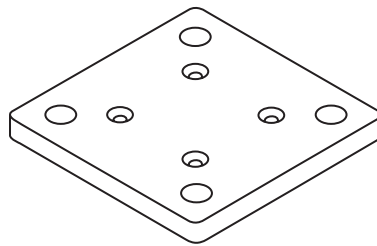

**FPA2 DURASLAT BASE PLATE**

Part # 1331153

Finish: Mill Finish Aluminium

Qty: Each

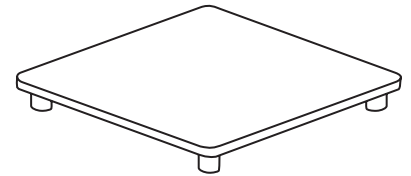

**FPA3 DURASLAT 50mm MALE END CAP**

Part # 1331154

Finish: Black Plastic

Qty: Each

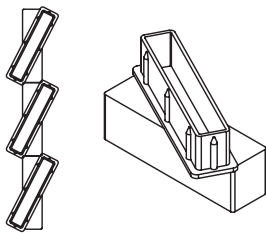

**FPA4 DURASLAT PRIVACY ADAPTOR**

Part # 1330027

Finish: Black Plastic

Qty: 10 Pairs per pack

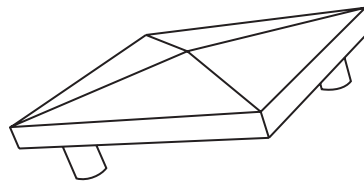

**FPA6 DURASLAT FP56 END CAP**

Part # 1330070

Finish: Black Plastic

Qty: 10 Pairs per bag

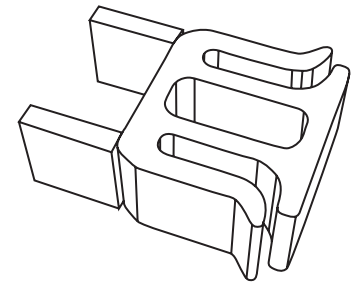

**DURASLAT SPACER**

Part #

**FPA8 (8mm)**

1330071

**FPA20 (20mm)**

1330072

Finish: Black Plastic

Qty

100 Per Bag

100 Per Bag

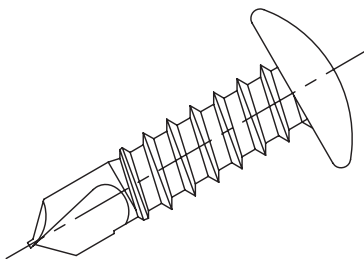

**SELF DRILLING WAFER HEAD SCREWS (10g x 16mm)**

Part # 1383170

Finish: Galvanised

Qty: Box of 1000

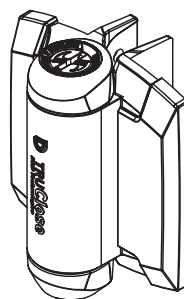

**TRUCLOSE HINGE-STD DUTY-2 LEGS-TCA1L2S3BT**

Part # 1332035

Finish: Black Plastic

Qty: Each

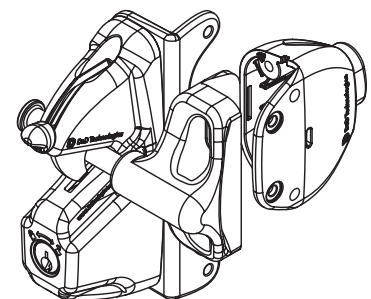

**LOKKLATCH DELUXE - LLDABS2L**

Part # 1332160

Finish: Black Plastic

Qty: Each

**HEAD OFFICE** | 3 Alspec Place Eastern Creek NSW 2766  
Phone: 02 9834 9500 | Fax: 02 9834 9532 | [info@alspec.com.au](mailto:info@alspec.com.au)

**SYDNEY BRANCH**  
3 Alspec Place  
Eastern Creek NSW 2766  
Phone: 02 9834 9500  
Fax: 02 9834 9555  
[sydney@alspec.com.au](mailto:sydney@alspec.com.au)

**NEWCASTLE BRANCH**  
95 Griffiths Road  
Lambton NSW 2299  
Phone: 02 4952 9111  
Fax: 02 4952 9728  
[newcastle@alspec.com.au](mailto:newcastle@alspec.com.au)

**PERTH BRANCH**  
30 Holder Way  
Malaga WA 6090  
Phone: 08 9209 9100  
Fax: 08 9209 9199  
[perth@alspec.com.au](mailto:perth@alspec.com.au)

**CAIRNS BRANCH**  
11 Southgate Close  
Woree QLD 4868  
Phone: 07 4037 6666  
Fax: 07 4037 6699  
[cairns@alspec.com.au](mailto:cairns@alspec.com.au)

**BRISBANE BRANCH**  
8-22 Jutland Street  
Loganlea QLD 4131  
Phone: 07 3089 4900  
Fax: 07 3089 4999  
[brisbane@alspec.com.au](mailto:brisbane@alspec.com.au)

**ADELAIDE BRANCH**  
1 Pope Court  
Beverley SA 5009  
Phone: 08 8150 6960  
Fax: 08 8150 6999  
[adelaide@alspec.com.au](mailto:adelaide@alspec.com.au)

**TOWNSVILLE BRANCH**  
28 Camuglia Street  
Garbutt QLD 4814  
Phone: 07 3089 4965  
Fax: 1300 131 747  
[townsville@alspec.com.au](mailto:townsville@alspec.com.au)

**MELBOURNE BRANCH**  
26-40 Pound Road West  
Dandenong South VIC 3175  
Phone: 03 8787 6333  
Fax: 03 8787 6399  
[melbourne@alspec.com.au](mailto:melbourne@alspec.com.au)

**DARWIN BRANCH**  
25 Bishop Street  
Woolner NT 0820  
Phone: 08 8941 7300  
Fax: 08 8941 7322  
[darwin@alspec.com.au](mailto:darwin@alspec.com.au)



Call 1300 ALSPEC  
[alspec.com.au](http://alspec.com.au)